

klimaoprema

Operating rooms

Complete Solutions





About us

Klimaoprema Ltd is European manufacturer of operating rooms and cleanrooms for hospitals, pharmaceutical, food, microelectronic industry and laboratories. More than 40 years we design, manufacture and install complete solutions for projects around the World.

We are focused on providing better clinical conditions for surgical teams. Our operating rooms are safe and user friendly for the medical teams, patients and natural environment.

We guarantee world class quality and are holder of ISO 13485 for design, production, installation, validation and maintenance of products for operating rooms and related areas.

Production

Production processes are robotized and automated. Our Smart factory has the most modern and efficient cleanroom panel production line in the World. Production lines of big capacities provide continuous production flow to make delivery for the customer fast, cost effective and production with minimal waste.



520

employees



350 000

delivered products annually



43 000

m² production space



50

countries in our reference list



110

engineers



45

years of experience

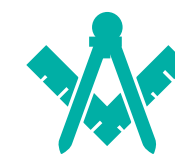

200 000

m² of installed operating rooms and cleanrooms



250

types of products

Business Areas

The OR is a dynamic work environment in which it is important to communicate, have sterile controlled conditions, filtered air and flushed antibacterial surfaces. We are planning, designing and making 3D visualizations and simulations for our customers according the hospital needs. We integrate all equipment and technology in the OR and suggest the best solutions.

Operating rooms



Staff & patient preparation rooms

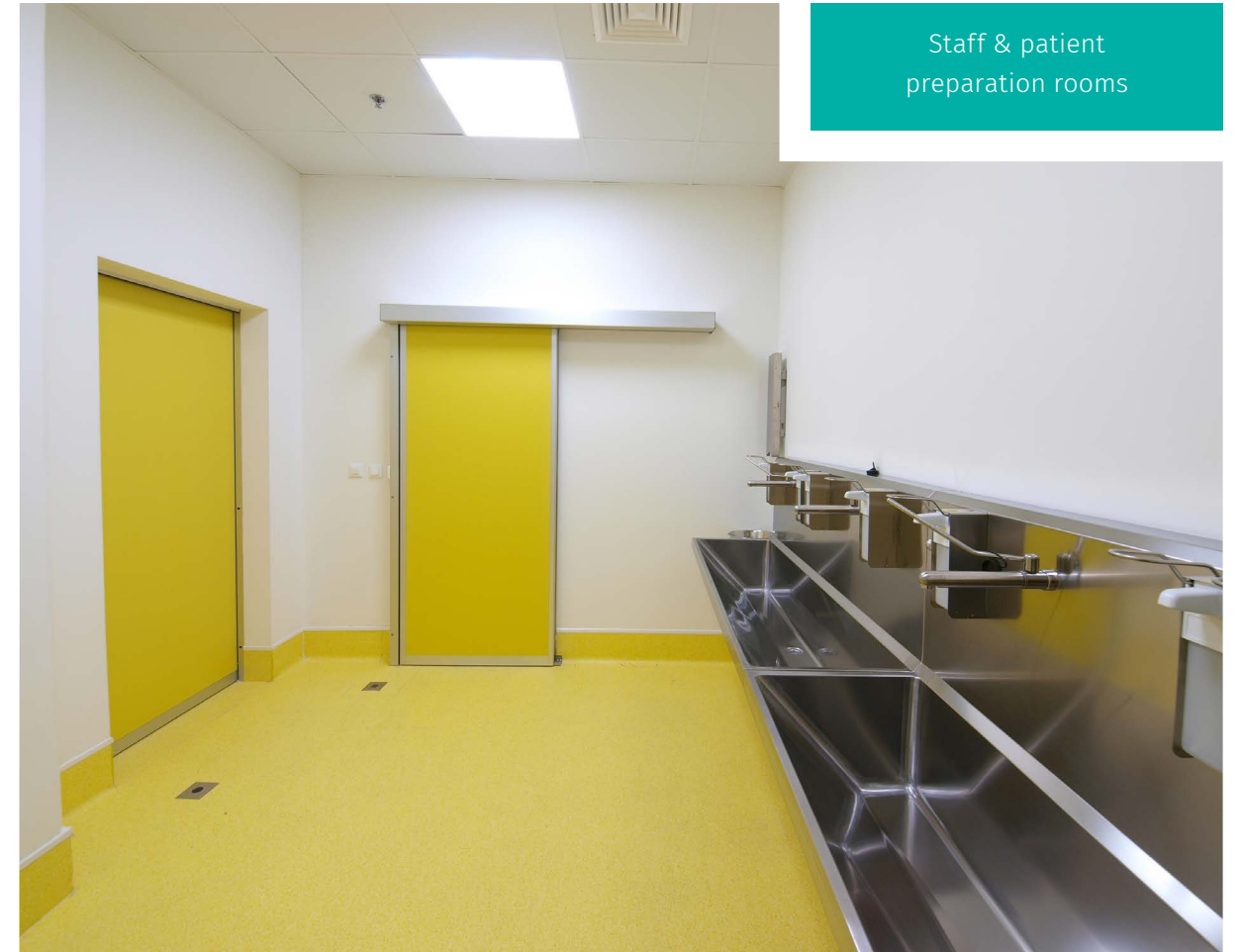

Intensive care units



Laboratories



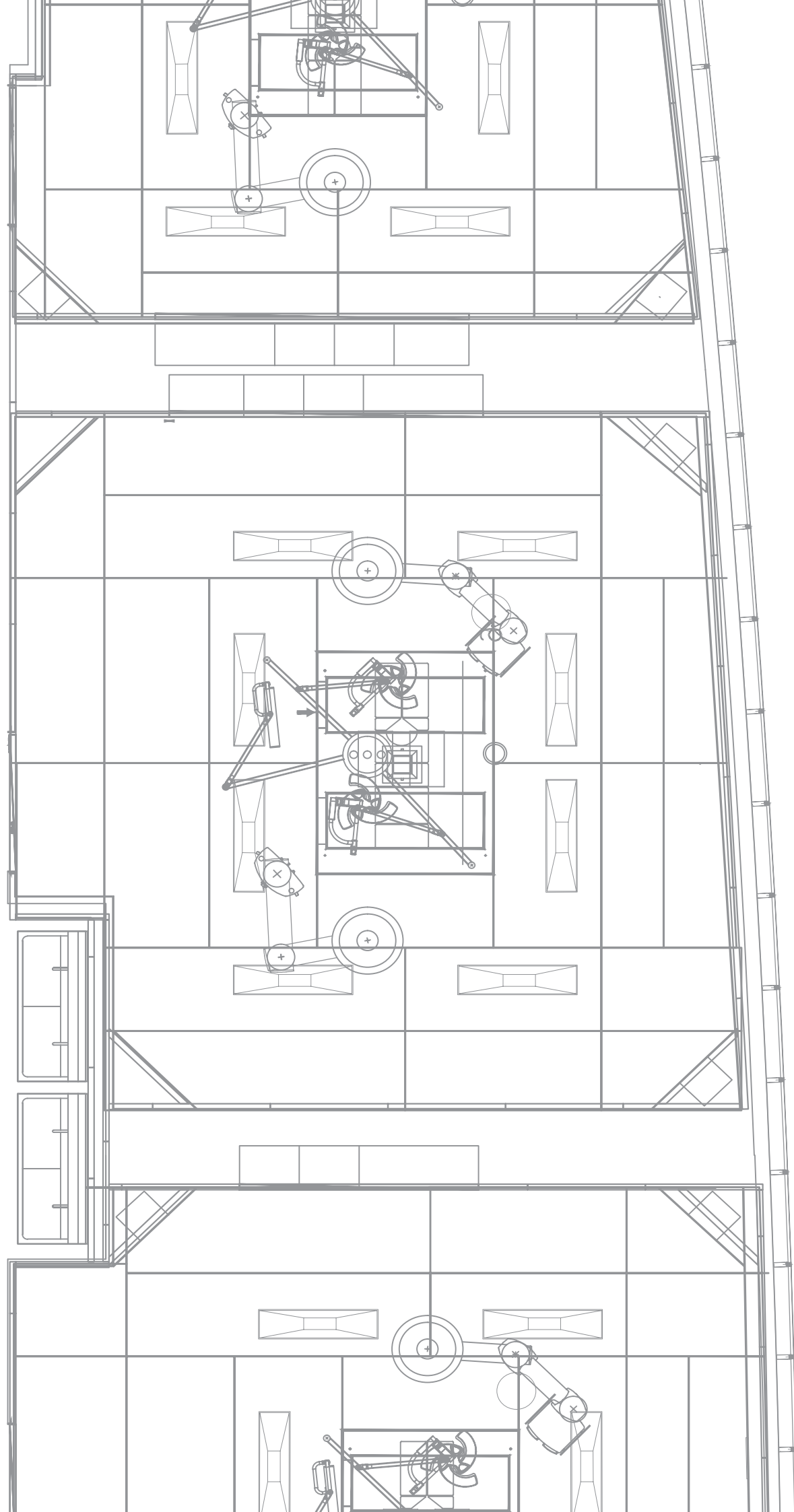

Project Management

Our architects and engineers have designed thousands of square meters of operating rooms and accompanying hospital facilities. We are supporting our customers through the whole investment cycle: designing, cost planning, tender procedure, project management until ready-to-use state.

Design & Engineering

Our solutions are in accordance with international regulations and norms, GMP and FDA guidelines. We are preparing complex 3D visualizations with the functional arrangement of the future interior.

- Technological solutions
- Architectural solutions
- HVAC installations
- Electrical installations
- Automation, BMS and DDC
- Technological media
- Hydro-technological installations

STAGE I - CONCEPTUAL DESIGN

Conceptual design is the foundation for further project development. It includes the elements of construction (size, position, orientation of the future project), defines sizes and elements of the rooms as well as medical technology in the room.

STAGE II - BASIC DESIGN

Basic design meets all standards and requirements for construction. It includes all installations, materials, etc. It also contains costs of the works.

STAGE III - DETAILED DESIGN

Detailed design elaborates the basic design and completes with technical solutions needed for construction. Detailed design is a project guide to the contractors to make the build easier and to prevent the improvisations.

Construction & Installations

We offer turn-key solutions for the OR's, which includes panel systems, HVAC installations, electrical installations, medical gas installations, AHU units and ventilation ducts.

As-built State

As-built state is detailed design with all the changes and supplements in accordance with performed works.



Construction

Turn-key solutions for the OR's include complete panel systems, mechanical, electrical, medical gas and HVAC installations.

HYGIENIC AIR-HANDLING UNITS

Hygienic air-handling units are made out of laminated galvanized sheet, stainless steel or sea-water resistant sheet. All parts are nonporous and do not absorb moisture. AHU units are produced according to hygiene and health requirements for design, installation, operation and maintenance of ventilation systems in hospitals: VDI 6022 Part 1, Part 3, DIN 1946 Part 2, Part 4, VDI 3803. AHU units can be independent of the existing building ventilation system, only for the OR or operation block. Also, it is possible to connect to the existing ventilation system.

Functional units:

- Suction/outlet mixing unit
- Filtering unit
- Heating unit
- Refrigeration unit
- Fan unit
- Humidification unit
- Unit with heat recovery device
- Sound attenuator

HVAC INSTALLATIONS

Temperature, air cleanliness, relative humidity, quantity of fresh outdoor air is defined and controlled. HVAC installations include ventilation grilles, ceiling diffusers, air regulation elements such as volume control dampers, sound attenuators, fire dampers according to EU norms EN 1366-2, EN 13501-4, EN15-650. All elements are produced in Klimaoprema.

MEDICAL GAS INSTALLATIONS

The pipeline distribution system is an integral part of all medical Gas Management Systems. It serves to bring all required medical gases (oxygen, medical air, nitrous oxide, nitrogen/surgical air, carbon dioxide) and vacuum to areas where they are needed. Through reliable partners we provide quality installation and a thorough testing regime for the security needed in a hospital environment.

Complete Solutions

Step-by-step development is done in all, large regional hospitals and small local hospitals, as well as in private clinics.

Operating rooms are design in a way that prevents the possibility of containing impurities such as dust, particles, microbes or aerosols. Filtered air is in positive pressure, it is effectively flushed and all parameters such as temperature, humidity, noise, illumination, etc. are controlled and do not affect the quality of operations or devices.

Basic process energy sources are an integral part of OR and their distribution to the place of consumption is carried out with the shortest trains, optimal workflow is provided.

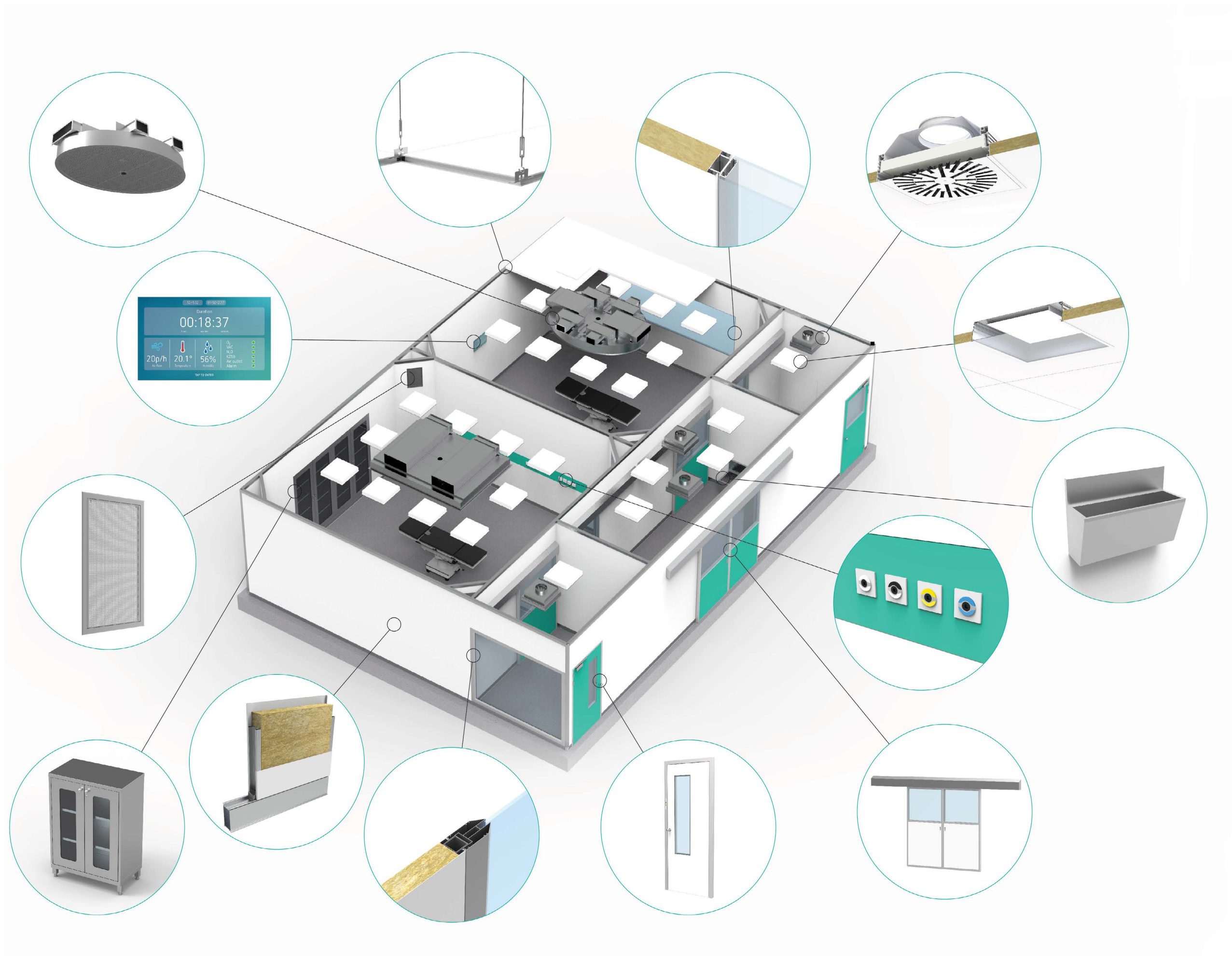

Panel Colors

Colors reflect moods and feelings, our architects will help choose the right color in careful selection. Colors run through the entire thickness of the material. They do not wear away or fade.

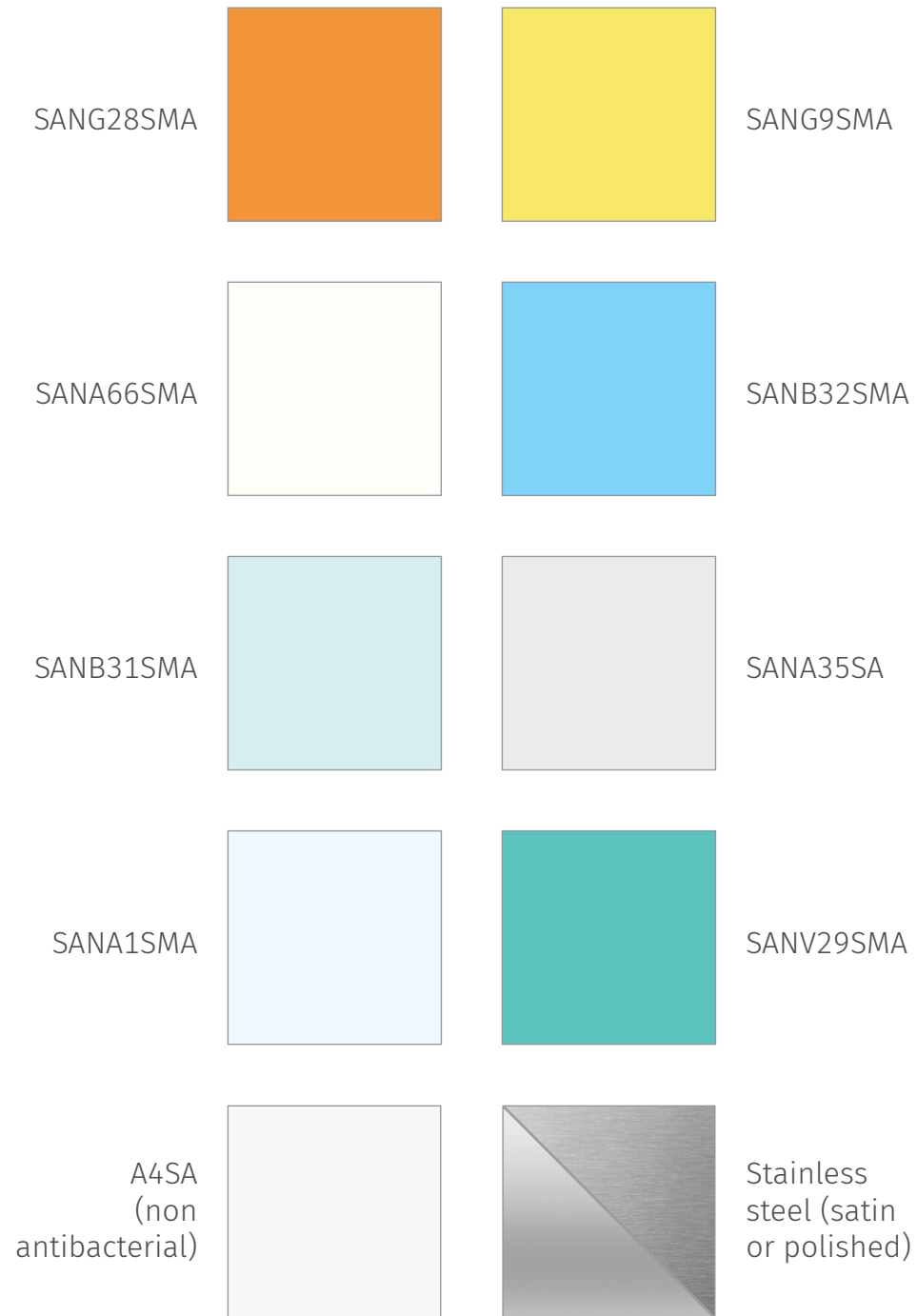

The colors shown are approximate and may vary depending on the product supplied. You can request exact samples (colors and textures) of the panels at: info@klimaoprema.com

Materials

STEEL SHEET

Wall and ceiling panels are made out of Stainless steel sheet (304/316), Aluminium sheet or Galvanized steel sheet. Stainless steel is the most used due to the advantages in technical and economical aspects. Powder coated steel is available in different colors, it is environmentally friendly and resistant.

ANTIBACTERIAL COATING

Antibacterial coating with silver ion treatment is permanently and reliably protecting the walls and ceilings against the growth of bacteria such as Escherichia coli, Salmonella, Legionella, Listeria and others. Antibacterial coating is incorporated into products at the time of production, making them clean and safe.

GLASS

Glass walls and windows are flushed with walls. Windows can be made with automatic blinds inside or with self-dimming touch system. Behind the glass graphics can be printed.

RADIOLOGICAL PROTECTION

When radiological protection is required, lead of adequate thickness is used at the backside of the panels and supporting structure.



Operating room panel system

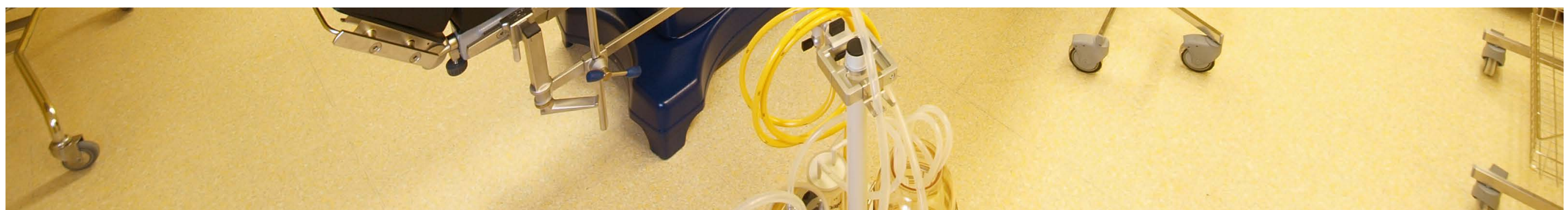

Panel composition

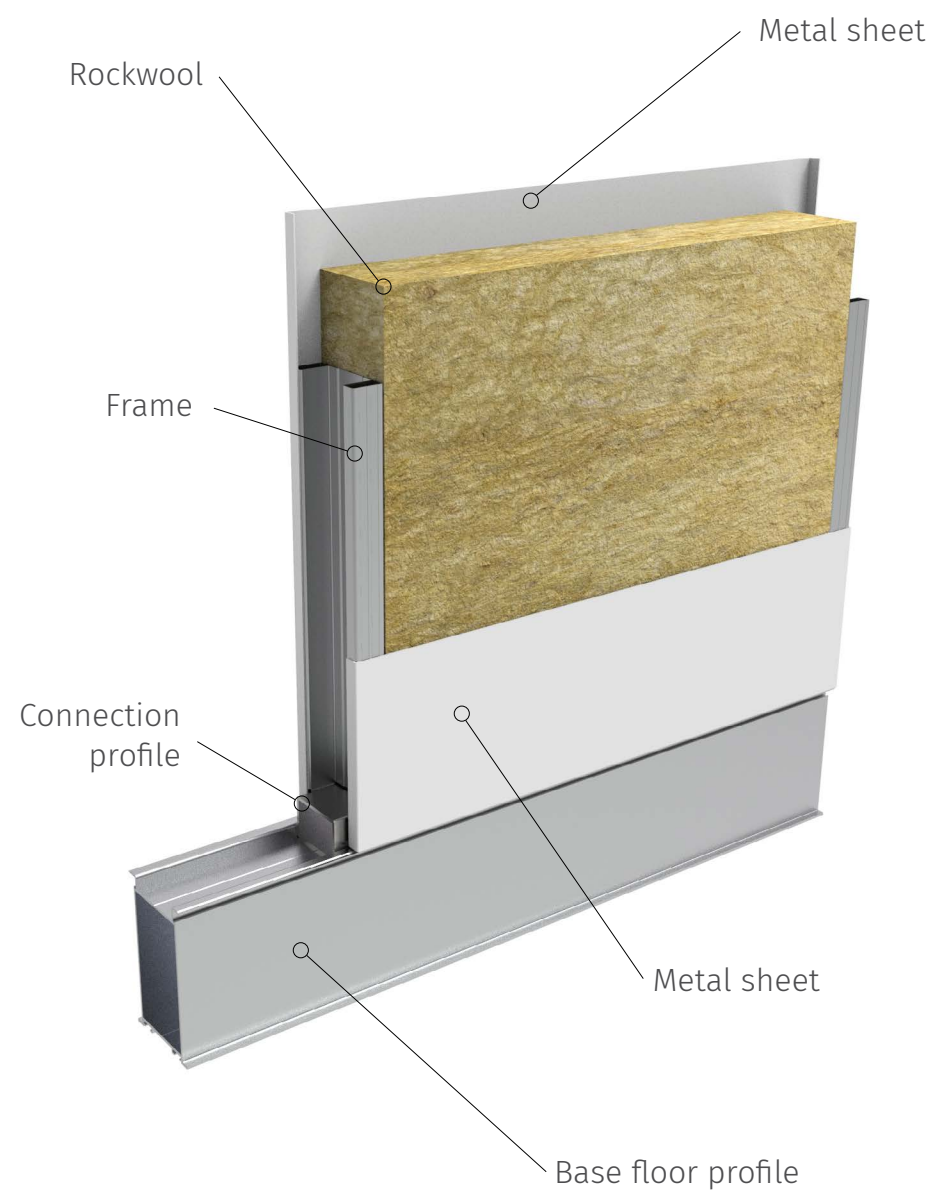

Panel system

OR panels are made out of two metal sheets, folded all around the edges of metal frame. Panel is filled with high density rockwool 100 kg/m³. The frame is channel shaped and it covers panels interior totally. Channels are for distribution of electrical wiring. The whole entity represents solid monoblock element. Panels are made according to the EU GMP and ISO 14644 requirements. Panel thickness is 62 or 82 mm.

PROPERTIES

- Strength
- Smooth, bump free surface
- Easy cleaning and maintenance
- Non-porous structure
- Watertight and water resistant
- Thermal and sound insulation
- Corrosion protection
- Long lasting
- Solid monoblock element
- Easy installation

ANTIBACTERIAL PANEL SYSTEM

Antibacterial coating is 110 microns thick. Antibacterial properties are achieved in the presence of environmental conditions enabling growth of bacteria. As an integral component of the surface, ions of silver continue to be effective without any loss during the entire lifecycle.

INTEGRATED PANEL SYSTEM

With modular walls OR is designed according to customer's needs. Installation of new technologies can be done overnight, without disturbing daily activities. OR is flexible to add new elements to an existing system. Doors, cabinets, windows, glass walls, monitors and technical equipment are flushed with the panels.

Aluminium floor profiles

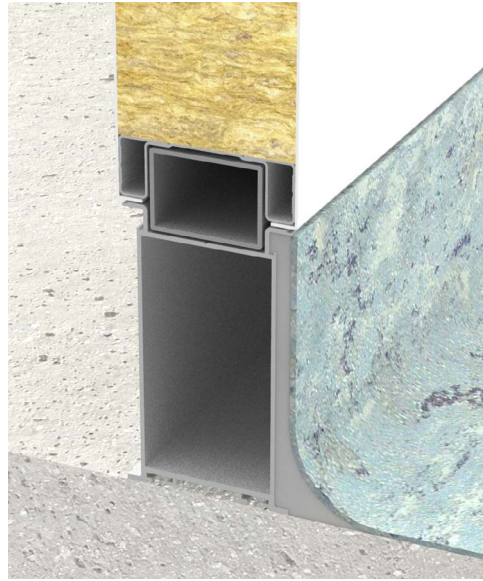

FTP1



FTP3

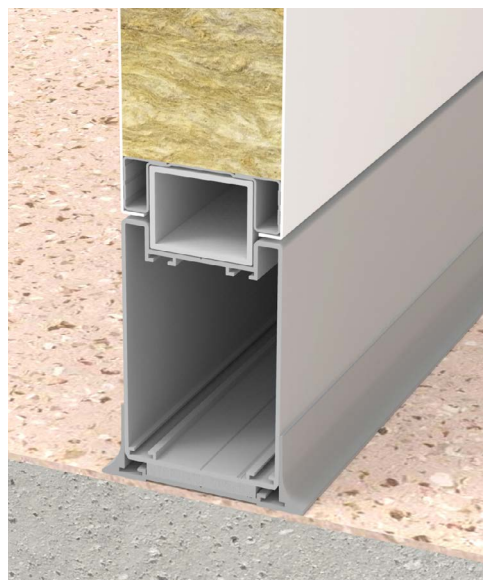

FTP5

Ceiling connection profiles

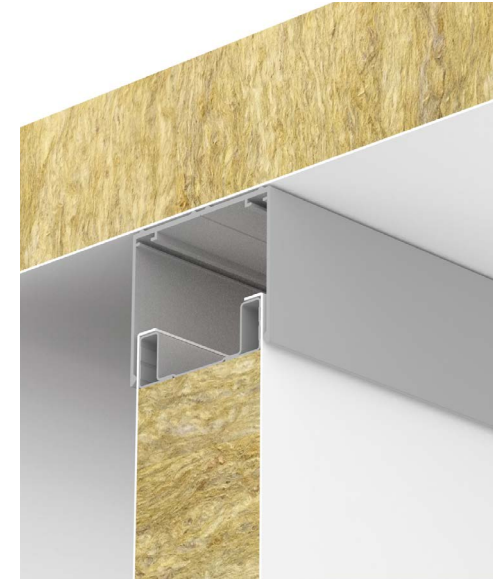

U-ceiling profile

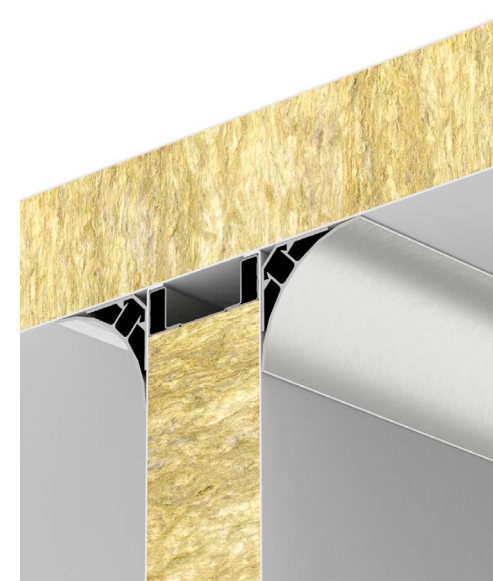

Aluminium cover

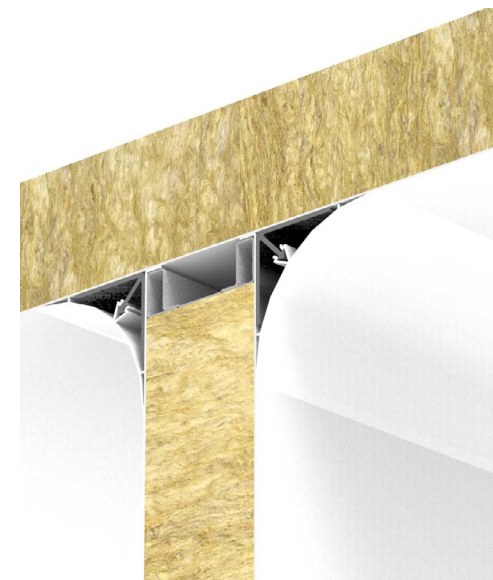

PVC cover

Stainless steel wall bumper



Stainless steel corner wall bumper



Stainless steel floor bumper



Stainless steel corner floor bumper



Stainless steel bumper

MATERIAL

- Stainless steel: AISI 304/316
- Polished or satin finish

DIMENSIONS

Wall bumper

- Min. length: 160 mm
- Max. length: 2950 mm

Wall corner bumper

- Min. length: 100 mm
- Max. length: 3000 mm

Floor bumper

- Min. length: 300 mm
- Max. length: 2100 mm

Floor corner bumper

- Min. length: 350 mm
- Max. length: 2100 mm

Ceiling system

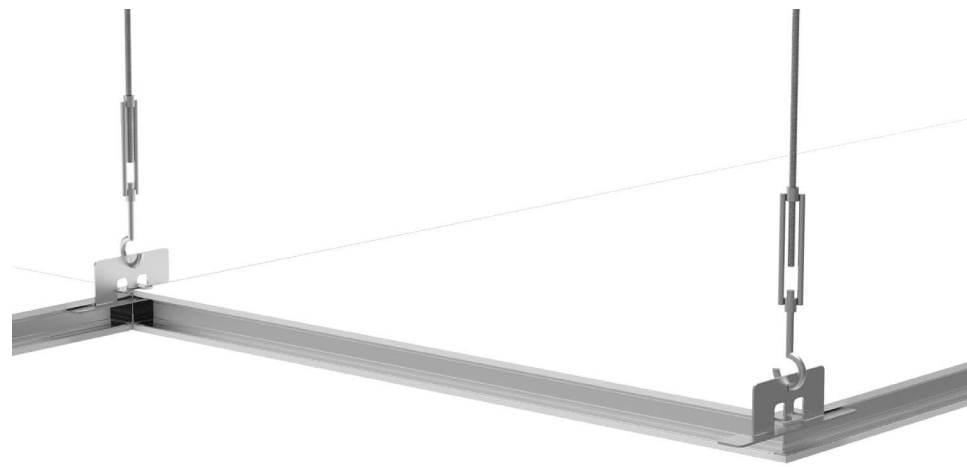

Walkable ceiling system

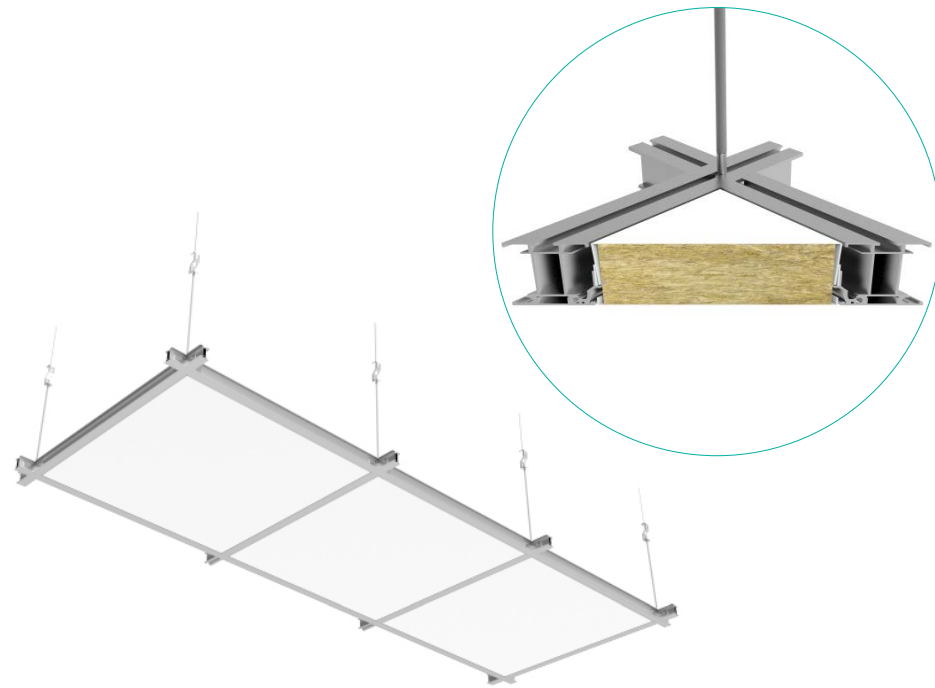

Non-walkable ceiling system

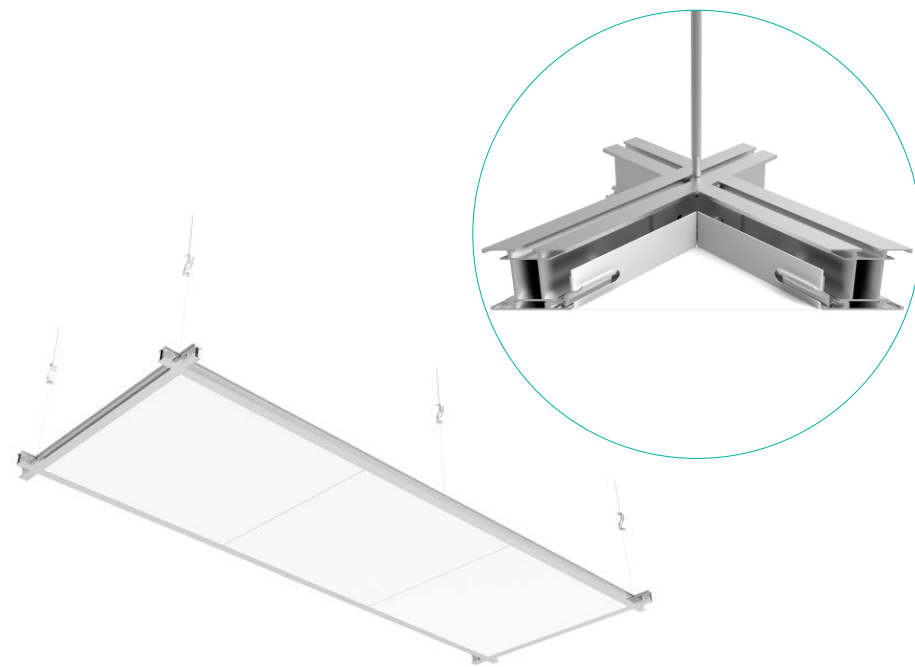

Ceiling panel system

Ceiling panel system is made in the same way as wall panel system, so the whole OR represents solid monoblock element. Ceilings are invisibly suspended on concrete or steel structure. The ceiling has custom made openings for installation of diffusers, lamps, skylights and other elements.

WALKABLE CEILINGS

Ceilings can be walkable or non-walkable. Walkable ceilings are used when above the OR are installations that need to be maintained. The load capacity for walkable panels is 200 kg/m².

ANTIBACTERIAL CEILING SYSTEM

Antibacterial coating is 110 microns thick. Antibacterial properties are achieved in the presence of environmental conditions enabling growth of bacteria. As an integral component of the surface, ions of silver continue to be effective without any loss during the entire lifecycle.

CEILING GRID SYSTEM

Ceiling grid system is made of aluminium profiles and panel filling. Panel consists of two metal sheets, folded all around the edges. Panels are made in the same way as wall panel system. This product is protected by patent.



Operation ceilings

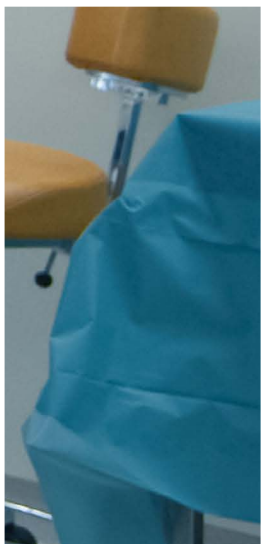

Cleanroom LED lamp



Ceiling elements section

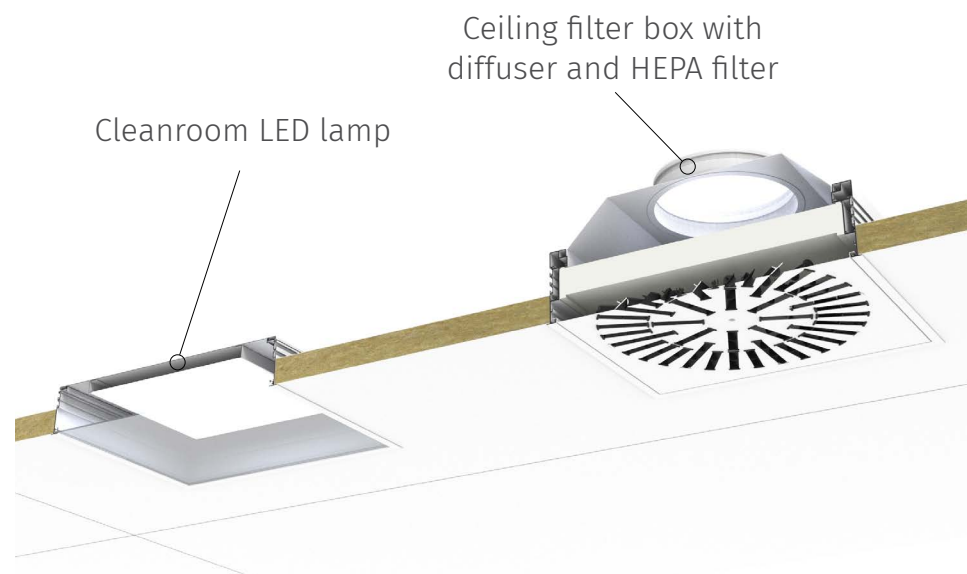

Operation ceiling section

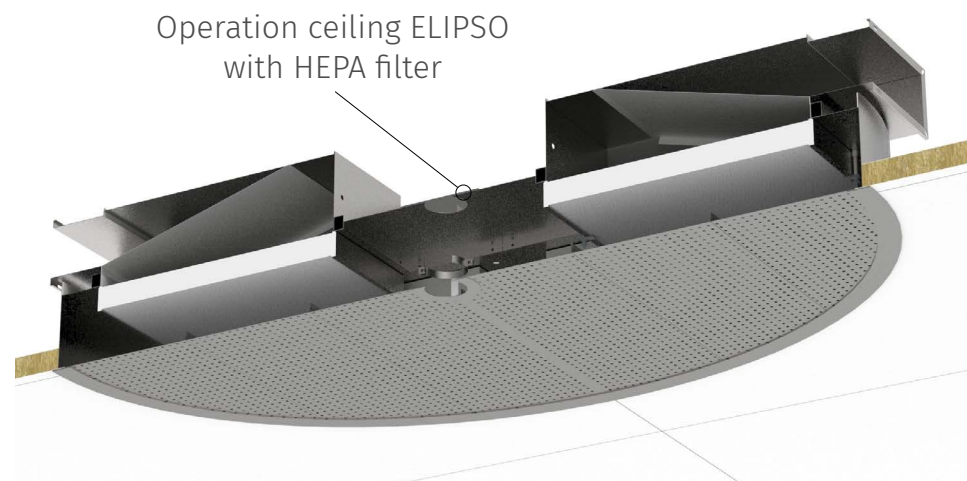

Cleanroom LED lamp

FEATURES

- Compact housing
- Easy installation
- Easy service from above
- Low thickness (<2 mm) and rounded profile visible from clean room space
- Frame profile compatible with profile of filter ceiling box
- IP 65 grade water protection
- Designed for panel thickness 40-82 mm

TECHNICAL INFORMATION

- Dimensions: 672 x 672 mm
- Mounting hole: 660 x 660 mm
- Power: 42.5 W
- Luminaire luminous flux: 6460
- Luminaire efficiency: 152 lm/W
- Input voltage: 230 V / 50 Hz
- Color temperature: 4000 K
- Supply unit: Integrated in the housing
- Options: Standard, DALI, Emergency (Integrated and Central)

CERTIFICATES





Operation ceiling ELIPSO

Exhaust perforated ceiling intended for supply of filtered air into OR's. Complete construction and outflow surface made out of stainless steel (polished). Absolute filtration by high quality HEPA filters class H14 (H13) according to EN 1822. Laminar air flow is gradually directed toward exhaust openings and optimal aseptic conditions are achieved. Recommended air flow velocity above operation table 0,15-0,30 m/s. DOP connection.

ELIPSO DESIGN

- Unique solution, industrial design right
- Energy efficient, no angles
- Complete laminar flow, without whirling
- Low pressure drop
- 100% clean conditions above operation table

OPTIONAL INSTALLATION

- Non-standard opening for surgical lamp or without opening
- Outflow surface made out of polyethylene fiber with lamps installed
- Installation of UV lamps in filter modules, air sterilization
- Installation of air regulation dampers into ventilation ducts
- Differential pressure gauge for HEPA filter control (0-500 Pa)
- Suspension with threaded rods
- Stainless steel satin surface

OPERATION PRINCIPLE

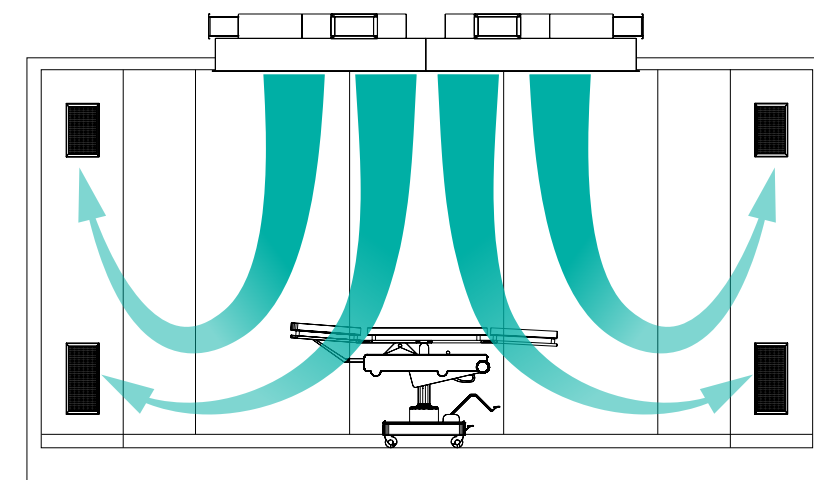



Operation ceiling SIP

Exhaust perforated ceiling intended for supply of filtered air into OR's. Complete construction and outflow surface made out of stainless steel (polished). Absolute filtration by high quality HEPA filters class H14 (H13) according to EN 1822. Laminar air flow is gradually directed toward exhaust openings and optimal aseptic conditions are achieved. Recommended air flow velocity above operation table 0,15-0,30 m/s. DOP connection.

OPTIONAL INSTALLATION

- Non-standard opening for surgical lamp or without opening
- Outflow surface made out of polyethylene fiber with lamps installed
- Installation of uv lamps in filter modules, air sterilization
- Installation of air regulation dampers into ventilation ducts
- Differential pressure gauge for HEPA filter control (0-500 Pa)
- Suspension with threaded rods
- Stainless steel satin surface

OPERATION PRINCIPLE

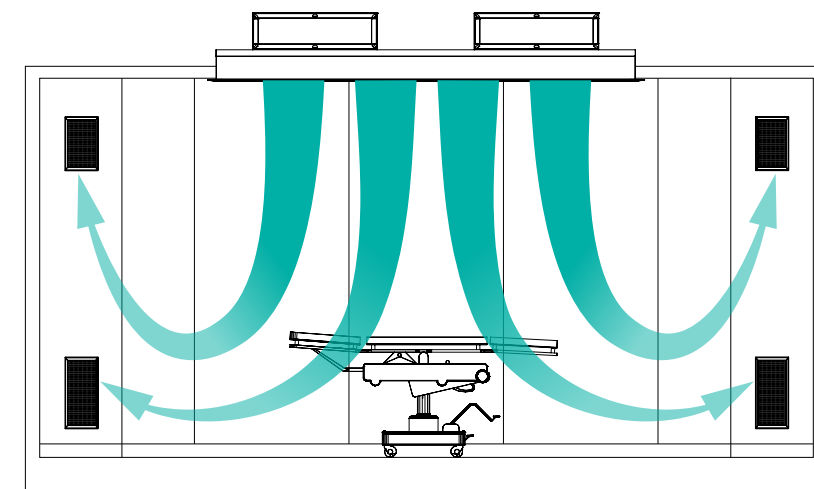



Exhaust surgical grille OPR

Exhaust surgical grille is made out of stainless steel, designed for wall mounting in OR's. Possible option with filter class G4 or with regulation damper. The grille opens with a single click and allows easy cleaning.

OPERATION PRINCIPLE

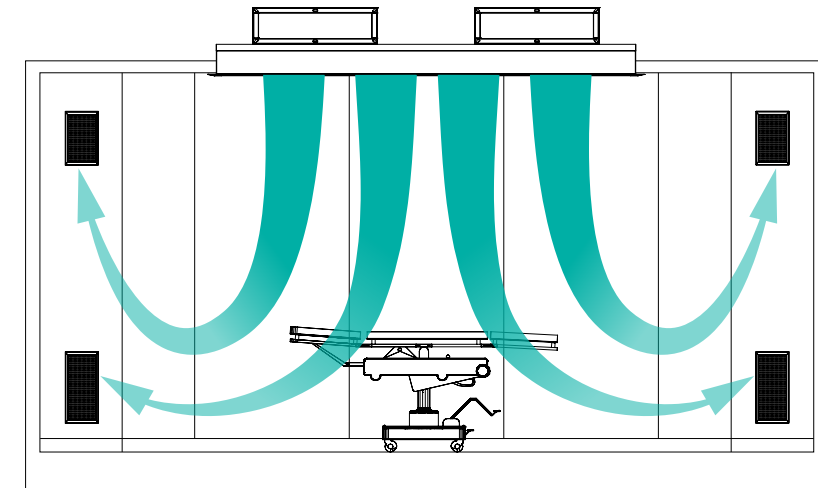

Inclined outflow box KIK

Inclined outflow box intended for supply of filtrated air into operating rooms and intensive care units that have limited ceiling height, which prevents operating ceilings to be installed. Complete construction and outflow surface made out of stainless steel.

OPERATION PRINCIPLE

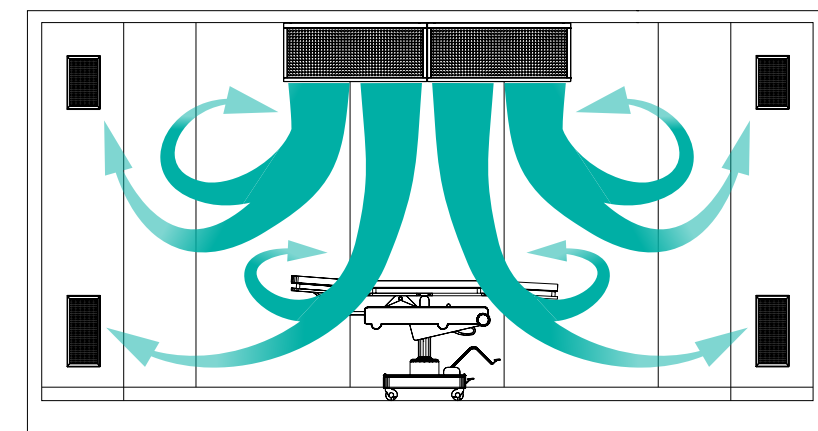

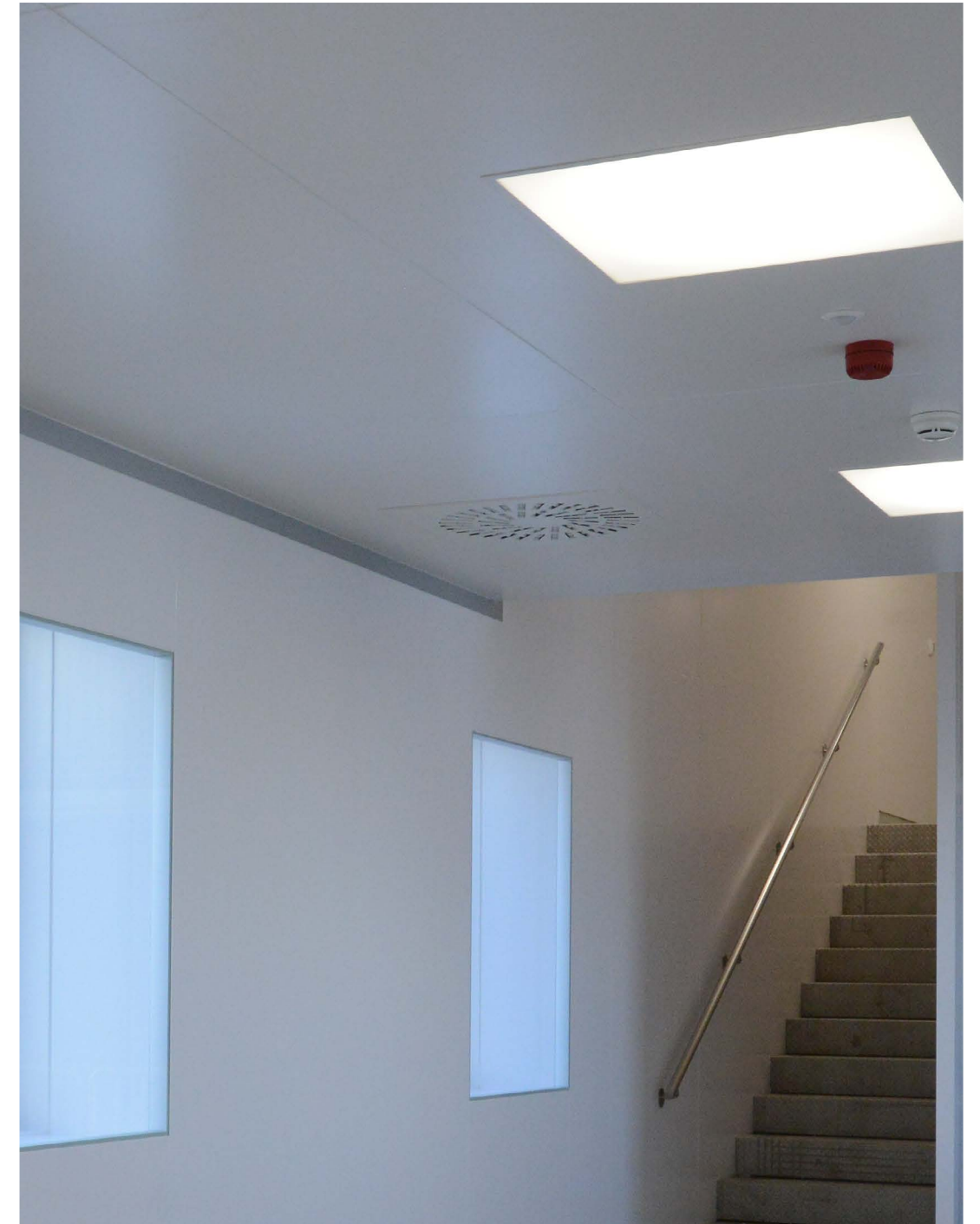

Windows and glass walls

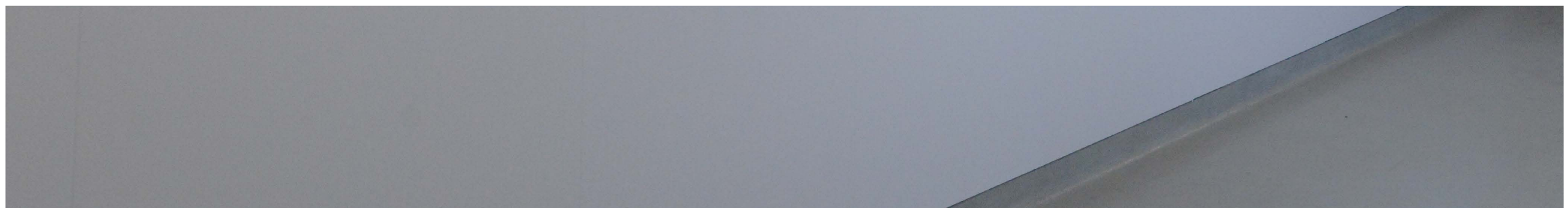

Glass wall composition

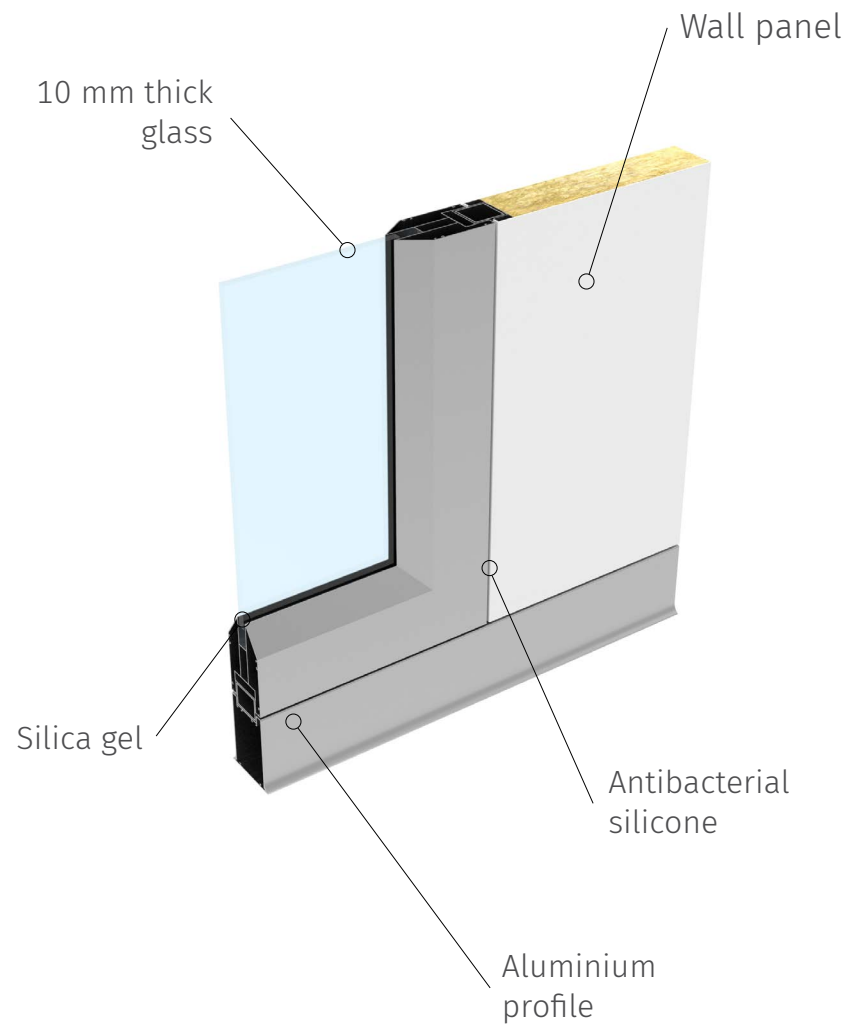

Window composition

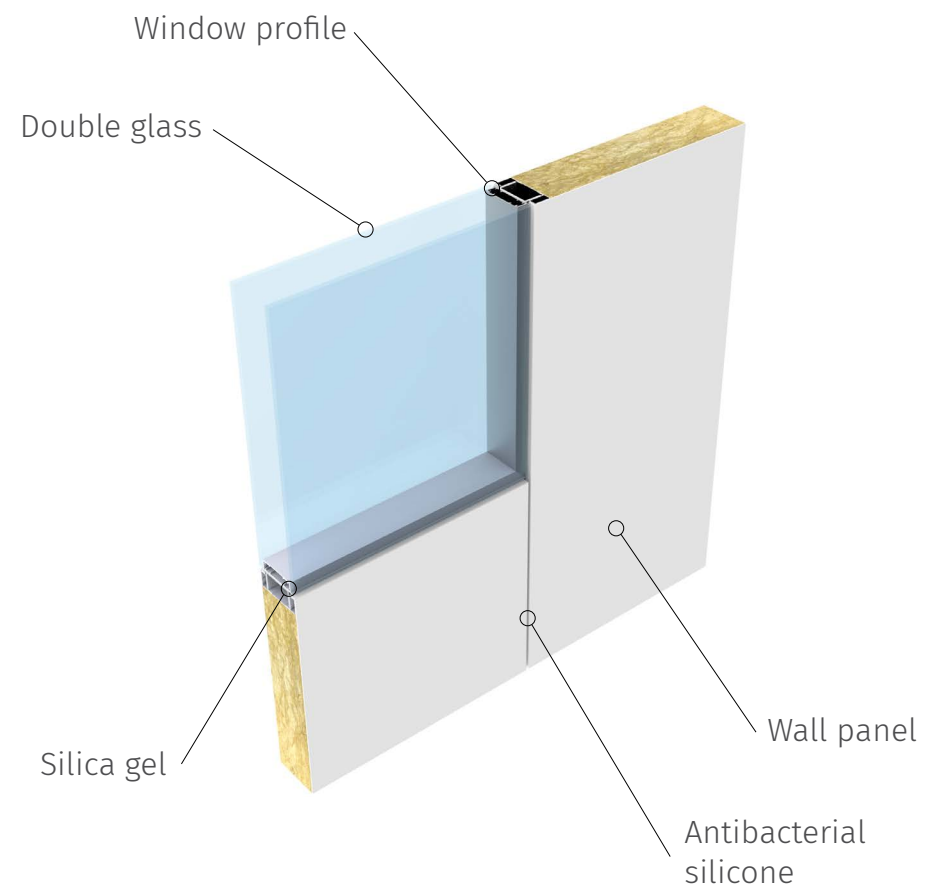

Windows and glass walls

Windows and glass walls are made according to EU GMP and ISO 14644 standards and are integral part of the wall panel.

Window is made out of double glass 6+6 mm and the frame is aluminium profile. In the frame is silica gel that absorbs moisture to avoid condensation in empty space between the two glasses. Window thickness (62, 82 mm) is as the thickness of the wall panel, so the surface is flushed, without bumps and without the possibility of bacteria growth. All joints are siliconized with non toxic fungicidal silicone.

Glass wall system consist of special frame made of aluminium profile and laminated glass thickness 10 mm.



Double glass on existing building element

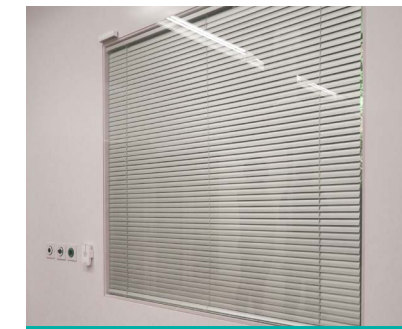

Installed blinds

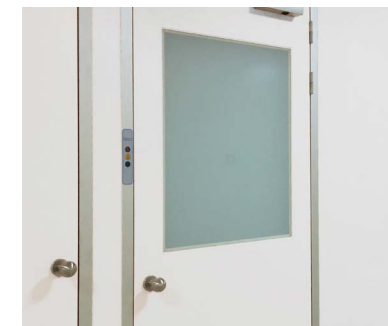

Blurry glass



Edge bumper



Floor bumper



Wall bumper

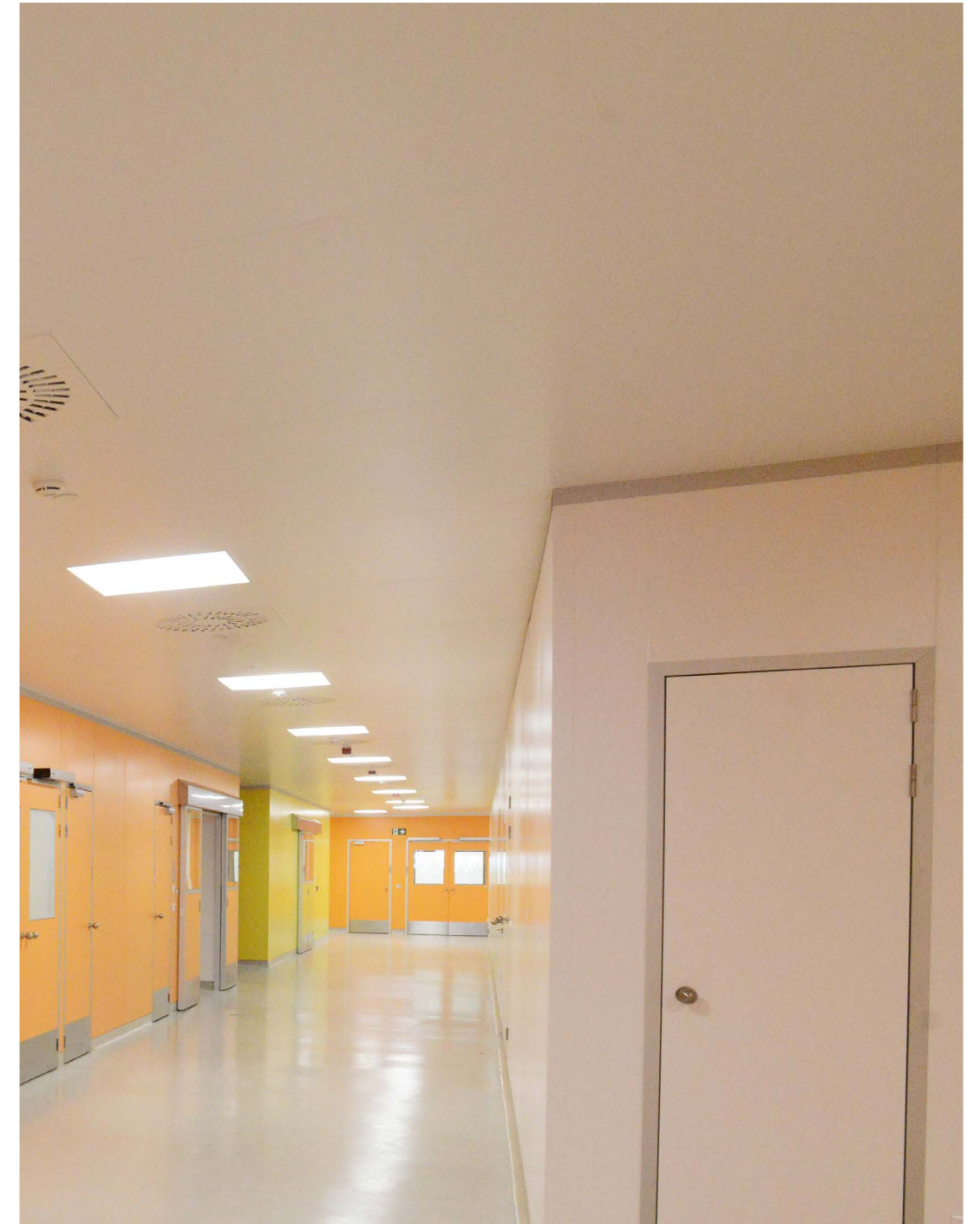

Operating room doors

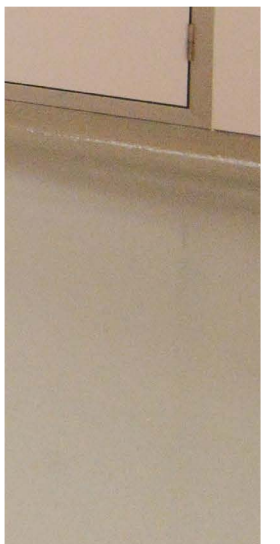
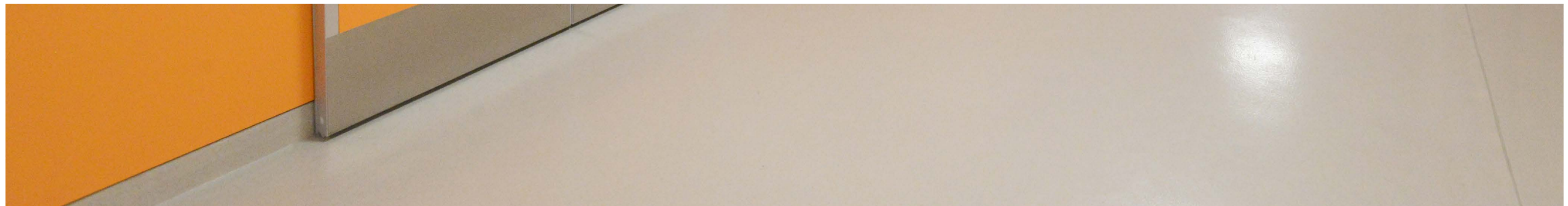



Swing doors

Swing doors for OR's are made according to the EU GMP and ISO 14644 requirements. Door frame is made out of aluminium profile. The door represent one solid element flush with wall panels. Door leaf is made out of metal sheet, filled with high density rockwool 100 kg/m³ or aluminum honeycomb core. Door handles and hinges are made out of stainless steel. "Drop seal" at the under side completely heads off air leakage. Doors are designed to maintain overpressure in the room. Doors can be equipped with windows, viewers and x-ray shields.

Sliding doors

Sliding doors for OR's are made according to the EU GMP and ISO 14644 requirements. Door frame is made out of aluminium profile. Door leaf is made out of metal sheet, filled with high density rockwool 100 kg/m³ or aluminum honeycomb core. The guide rail cover is made out of stainless steel, with angle for easier cleaning. Doors are designed to maintain overpressure in the room. Automated systems for both sliding and swing doors are provided by reliable manufacturers. Doors are operated from wall board, elbow buttons or hand opening. Doors can be equipped with windows, viewers and x-ray shields.



Door automatisaton



Building Management System



Home screen



Interface control screen



Warning color

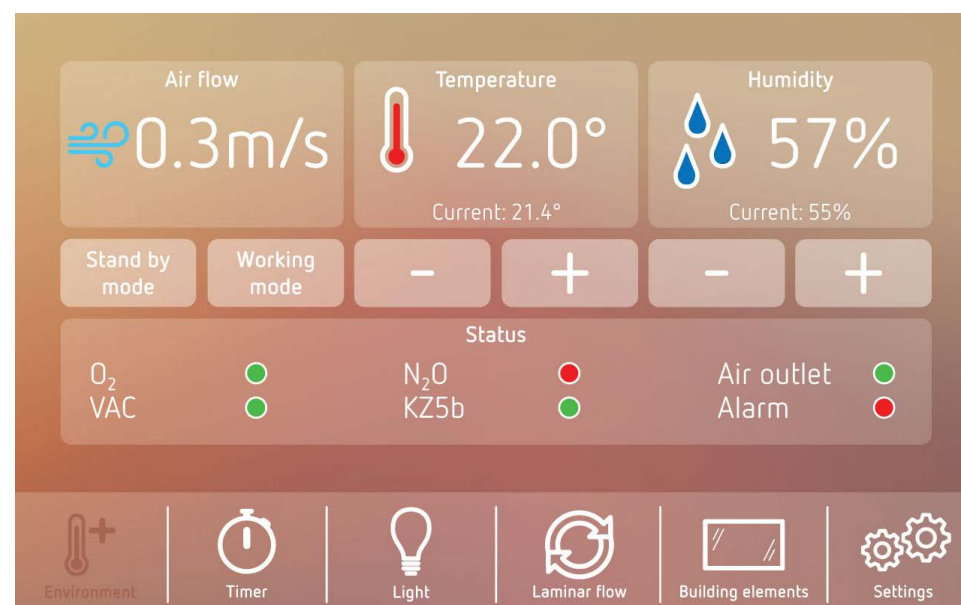

Building management system (BMS)

BMS controls and supervises HVAC and electrical installation in hospitals and OR's, such as: heating, cooling, air-conditioning, ventilation, lighting, power systems, fire system, safety systems, etc.

When configured properly, significant energy saving is achieved. Different configuration according the hospital needs is possible.

SYSTEM FUNCTIONS

- Control and regulation of comfort conditions
- Central or remote control
- Possibility of individual control
- Simple, safe and fast detection of problems
- Effective monitoring of energy consumption
- Increased staff productivity
- Maintenance savings

CONTROL AND SUPERVISION IN OPERATING ROOMS

- Environment supervision (temperature, humidity, pressure, airflow) with alarm activation
- Medical gases statuses with alarm activation
- HEPA filter supervision with alarm activation
- OR's AHU start/stop and general status/alarm info
- Local date/time (operation duration only for info, not for the medical record)
- Light control/regulation
- Doors/windows control
- Setting of HVAC parameters
- Intercom



Staff preparation rooms
Intensive care units





Staff and patient preparation rooms

In staff and patient preparation rooms it is necessary to prevent contamination and the spread of bacteria. Each square meter is essential, usable and often limited space, so standard furniture is often not the optimal solution. We design and manufacture stainless steel furniture according to special requirements and user needs.

STAINLESS STEEL FURNITURE

Furniture is made out of stainless steel and consists of vertical holders and surfaces. Furniture elements are made of sound-insulating panels, welded tightly and processed to prevent the possibility of collecting bacteria. All elements (handles, hinges, hooks, adjustable feet's, etc.) integrated in the furniture are made out of stainless steel. Surfaces can be made out of different material (satin/polished/perforated stainless steel, kerrock, marble, etc.). Furniture is simply handled, easy to maintain, resistant to cleaning agents and disinfectants, suitable for OR's and preparation rooms.

- Sinks
- Cabinets
- Trolleys
- Tables
- Drawers
- Shelves
- Benches
- Hangers

SURGICAL SCRUB SINKS

Made out of stainless steel, different sizes and dimensions depending on the space and user requirements. Various models: wall mounted, freestanding, hanging, double sinks, etc. Additional equipment: waste basket installed, sensor taps, soap and disinfect holders, etc.

CABINETS

In the OR stainless steel cabinets are installed in the wall. Cabinets are flushed with the wall, with no bumps. Different sizes and dimensions depending on the space and user requirements. Various models: with doors, drawers, shelves, lockable, hinged or sliding doors, etc.



Intensive care units

In intensive care units (ICU) it is necessary to prevent contamination and the spread of bacteria. Antibacterial materials are used, as well as HEPA filtration to provide clean conditions and safe patient environment.

Clinical laboratories

In medical laboratories blood and other tests are done in order to obtain information about the health of a patient. Tests are done in safety devices. We produce microbiological safety cabinets that protect operator, work object and environment from possible contamination during the study or work with micro-organisms. The devices are produced in accordance with purity class ISO 5 (4), 100 (10) class by U.S.F.S.209 E, GMP class A and validated with IQ/OQ/FAT/SAT documentation. All devices can work 24/7.

- Microbiological safety cabinets
- Laminar flow devices
- IVF hoods
- Pass-boxes
- Filtration elements





References



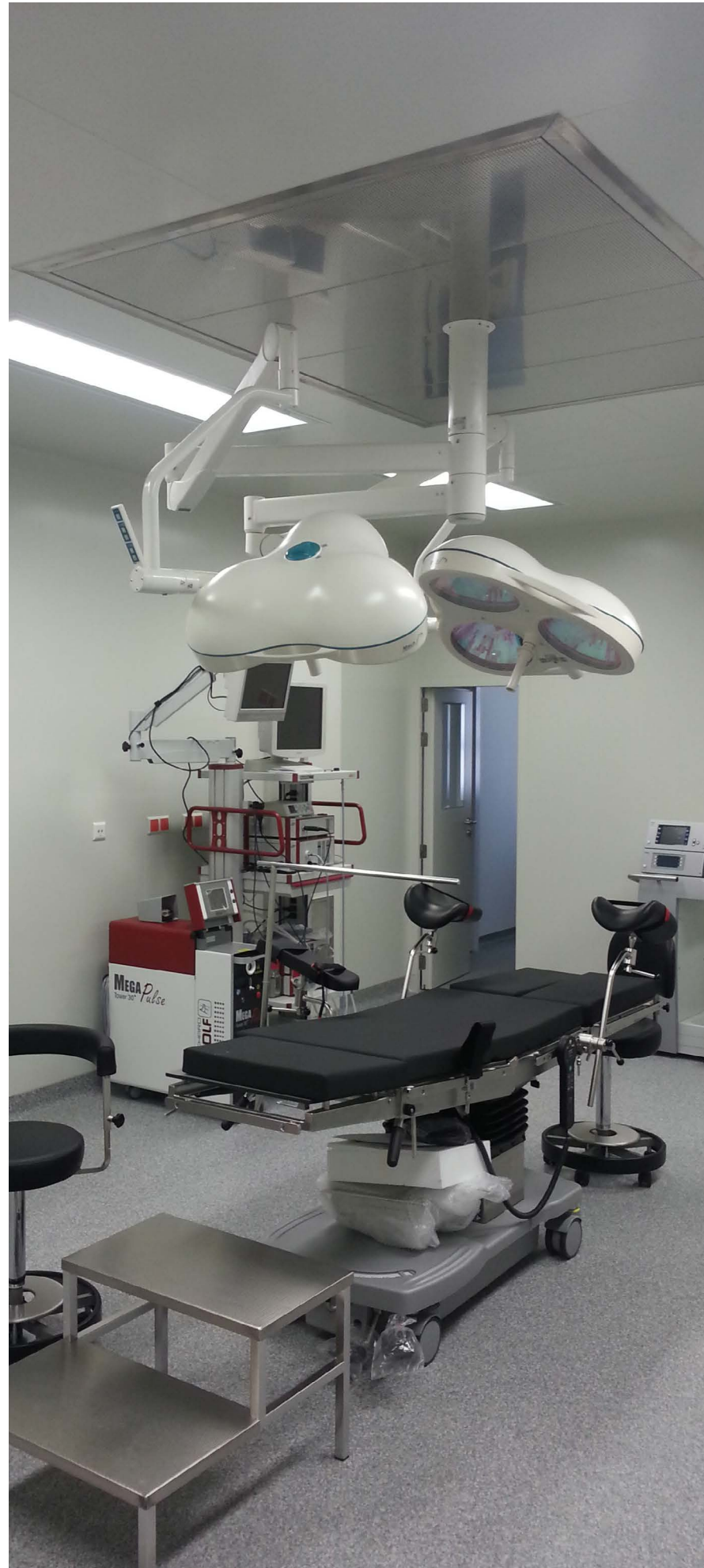

References



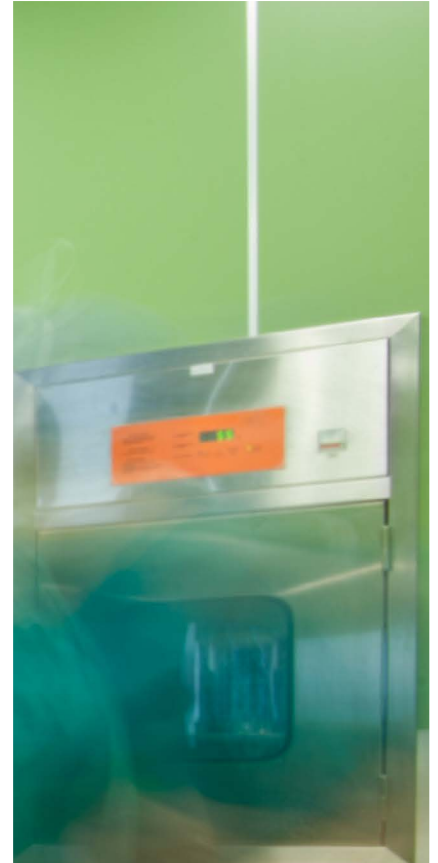

**klimaoprema**
CLEANROOM SOLUTIONS

Address: Gradna 78A,
10430 Samobor, Croatia
Tel.: +385 1 33 62 513
Fax.: +385 1 33 62 905
E-mail: info@klimaoprema.com
Web: www.klimaoprema.com

December, 2022

